

Daily Maintenance Sheet for VJ-426UF

Daily maintenance

The content of this documents are based on the specification of the firmware Ver.1.05 or later.

When to maintain:

- After operation (Be sure to perform the following maintenance)
- When the media strikes the print head

Required Items:

- (a) Plastic gloves (Supplied accessories or Commercial item)
- (b) Rubber gloves (Supplied accessories or Commercial item)
- (c) Protective goggles (Supplied accessories)
- (d) Paper towel (Supplied accessories) or Polyester knit wiper (Optional accessories)
- (e) Dropper (Supplied accessories)
- (f) Dedicated maintenance cleaner (Optional accessories)
- (g) Plastic cup (Supplied accessories)
- (h) Cleaning stick (Supplied accessories or Optional accessories)
- (i) Tray (Supplied accessories)
- (j) Scraper (Supplied accessories)

※Use a paper towel supplied with the printer or optional Polyester knit wiper. DO NOT use a tissue.

Lints or flakes on tissue may cause damage to the print head.

※DO NOT use non-dedicated maintenance cleaner.

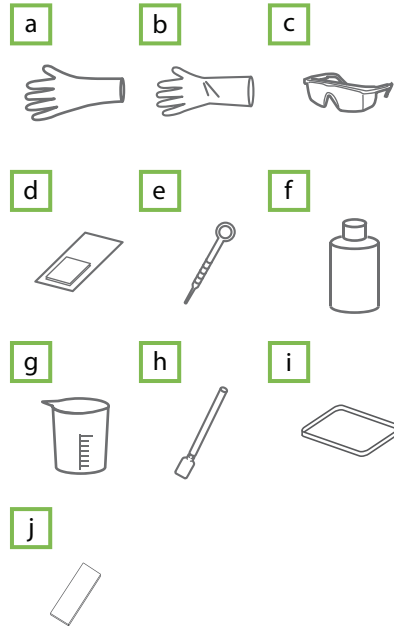

Preparation:

- Wear the rubber gloves (white) over the plastic gloves (pink).
- Wear protective goggles.

CAUTION

- ❗ Skin or eye contact with UV curable ink may cause skin inflammation or allergic reaction. For this operation, be sure to wear the supplied gloves (or solvent resistant gloves) and goggles to prevent ink from contacting with your eyes or skin.

Important!

Before performing maintenance, make sure to read "How to handle UV inkjet printer / its supplies" (supplied with the printer).

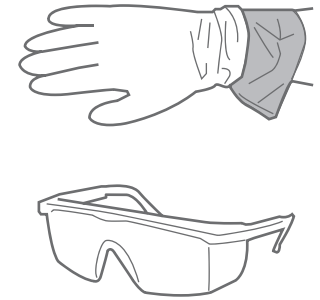

- Press the [MENU] key on the operation panel.
- Press the [+] / [-] key on the operation panel to select [Menu 5: Sleep Mode >].
- Press the [>] key on the operation panel.
- When [Sleep Mode 1: Start] appears on the operation panel, press the [Enter] key.
- When [Start Sleep Mode?] appears on the operation panel, press the [Enter] key.
- When [Daily Maint.: Start] appears on the operation panel, press the [Enter] key.
- When [Remove Media -> E] appears on the operation panel, remove the media and the jig on the table, and then press the [Enter] key.
- When [Daily Maint.: End] appears on the operation panel, you can start the maintenance with following steps.

※Make sure to complete this maintenance within 5 minutes while the printer is in Daily maintenance state.

1. Cleaning of UV Lamp

- 1** Open the front cover slowly, holding it by the places shown in the picture and using both hands.
Fully open the front cover.

※Do not place any object inside the printer.

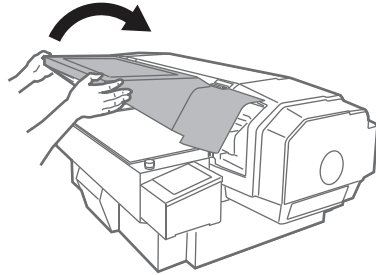

- 2** Look in the stainless tray to check for ink or dust on the UV lamp.

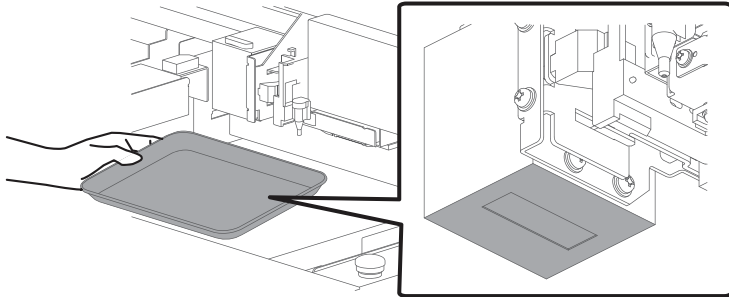

- 3** Using a paper towel, remove ink and dust from the UV lamp.

*If ink deposits cannot be removed with the paper towel, use the scraper supplied with the printer.

- Press the scraper on the ink deposits with a slight angle and scrape off the ink deposits.
- Use the paper towel to clean the ink scraped from the lamp.

Important!

- Make sure to use the scraper supplied with the printer.
- Never use the corner of the scraper. It can damage the UV lamp.
- When using the scraper, do not apply too much pressure to the lamp. It can damage the UV lamp.

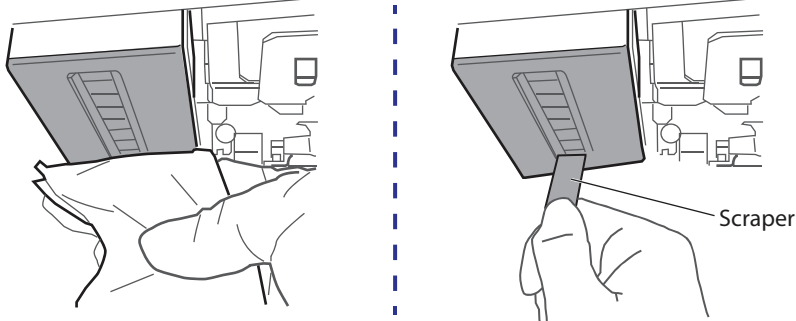

2. Moistening the surface of print head nozzles

Important!

During cleaning, please note the followings:

- Always follow this steps to perform daily maintenance.
When moistening the surface of nozzles, do not use the cleaning stick already used to clean the print head circumference, cleaning wiper or cap circumference. Doing so may result in damage to the print head.
- Always use a new cleaning stick and dampen it with dedicated maintenance cleaner.
DO NOT use non-dedicated maintenance cleaner. It may cause nozzle clogging.
- Do not touch the tip of a cleaning stick with fingers. If sebum is adhered, it can cause damage to the print head.
- Do not reuse a cleaning stick. Dusts can adhere causing damage to the print head.

- 1**
- Put a cleaning stick in the plastic cup.
 - Use the dropper to dampen the swab of cleaning stick with dedicated maintenance cleaner.
(Amount used: 0.5 ml)

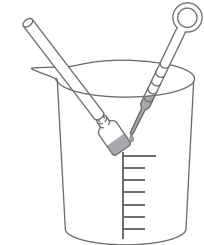

- 2**
- Look at the bottom side of the carriage.
Using the cleaning stick dampened with the maintenance cleaner, moisten the surface of the print head nozzles.

- Lightly touch with the cleaning stick to moisten the nozzle surface.
 - Repeat it a couple of times to moisten the entire nozzle surface.
- ※DO NOT rub into the nozzle surface. It can cause damage to the print head.
※If the entire nozzle surface has been moistened, you can stop it.

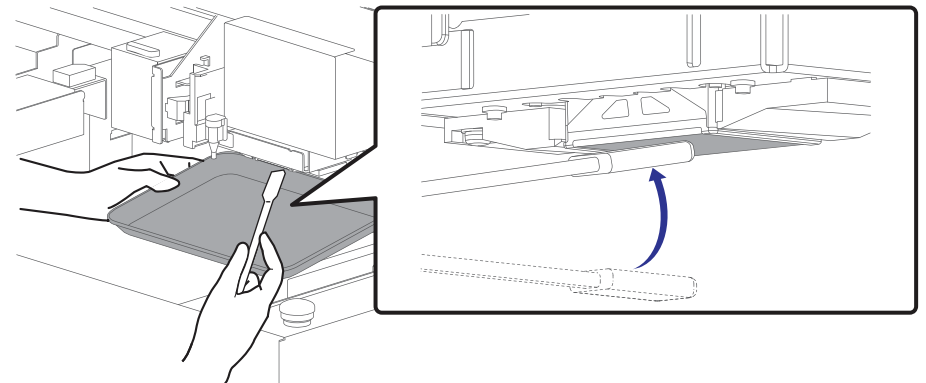

- 4** Next clean the print head circumference.

3. Cleaning of print head circumference

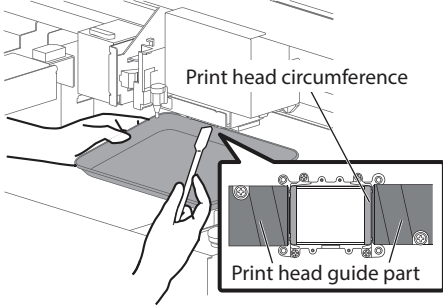
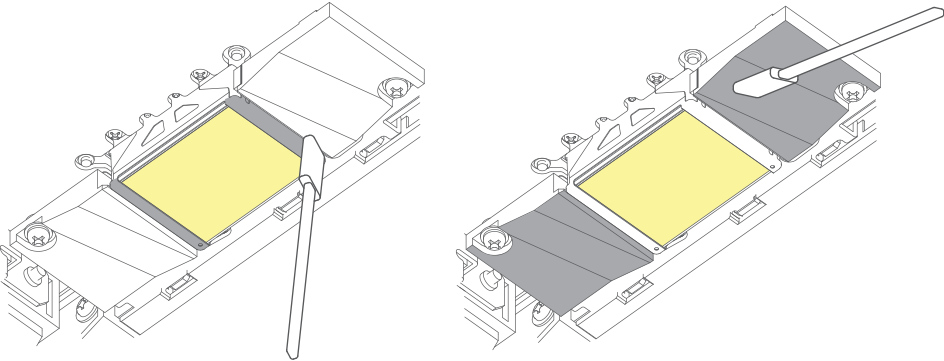
<p>1 Look at the bottom side of the carriage. Check if dusts and ink deposit are adhered.</p> <ul style="list-style-type: none"> • Print head circumference (silver metal part) • Print head guide part (black plastic part) <p>※If maintenance cleaner is splashed onto the printer, use a paper towel to wipe it off.</p>	
<p>2 Use the cleaning stick to remove the ink and dust on the bottom of the carriage.</p> <p>■ Cleaning required</p> <p>■ DO NOT touch the surface of a print head (the yellow portions in the illustration below)</p> <p>Print head circumference (silver metal part) Print head guide part (black plastic part)</p> 	
<p>3 Next clean the cleaning wiper and the cap circumference.</p> <p>※Before proceeding to the next step, if the cleaning stick gets dirty while cleaning, submerge the foam tip of the stick into the maintenance cleaner in the cup to clean it.</p> <p>※If the dirt does not get off, change the cleaning stick and then proceed to the next step.</p>	

4. Cleaning of cleaning wiper and the circumference of the cap

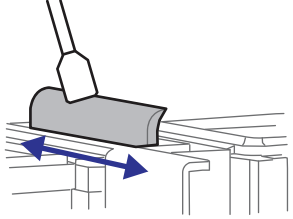
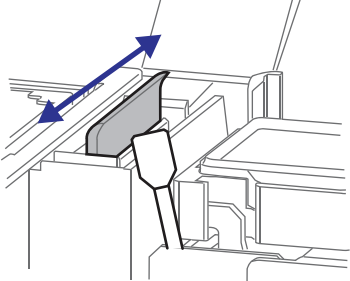
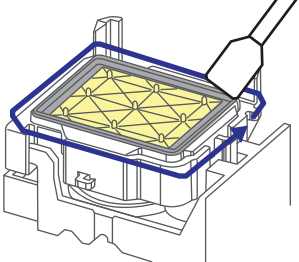
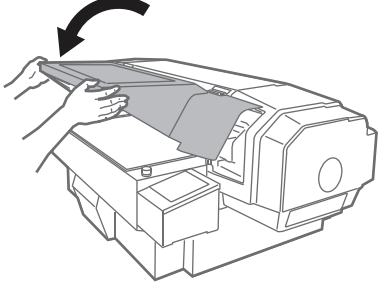
<p>1 Use the cleaning stick to clean the left side surface of the cleaning wiper (a black rubber part).</p>	
<p>2 Clean the right side surface of the cleaning wiper.</p>	
<p>3 Use the cleaning stick to remove the ink and dust on the circumference of the cap.</p> <p>■ Cleaning required</p> <p>■ DO NOT touch the absorber (the yellow portions in the illustration right)</p>	
<p>4 Close the front cover slowly, holding it by the places shown in the picture and using both hands.</p> <p>Next finish the daily maintenance.</p>	

5. Finishing daily maintenance

1 Press the [Enter] key on the operation panel.

- The printer automatically performs the Short cleaning.
- When the Short cleaning is complete, the printer automatically enters to sleep mode.

Daily Maint. : End

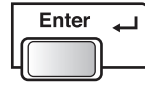

2 • Dispose of the used cleaning stick.

- Use a paper towel to wipe the maintenance cleaner off the dropper.
- Dispose of the maintenance cleaner in the plastic cup and dry the cup well using the paper towel.
- Use a paper towel to clean the tray.
- Now the daily maintenance is complete.

Important!

- Do not reuse a cleaning stick.
Dusts can adhere causing damage to the print head.
- Check that the lid of the maintenance cleaner is shut properly and store it.



Note

For purchasing the maintenance items, contact your local Mutoh dealer or nearest Mutoh sales office.

Name	Part Number	Minimum q'ty per order
Dedicated Maintenance cleaner	VJ-ULVA1-ML500	1
Polyester knit wiper	PJ-POLYNITW	300
Clean stick	RH2 Clean stick	100

Maintenance before leaving printer in sleep mode for a long time



<Preparations>

- ▶ **Make sure that there is enough ink in ink cartridges.**
 Operation manual "Checking ink level and replacing ink cartridge"
- ▶ **Empty the waste fluid tank.**
 Operation manual "Emptying waste ink tank"
- ▶ **Perform "Daily maintenance" (refer to [this sheet](#))".**

<When the printer has been left in sleep mode for one week>

To leave the printer in sleep mode for one week or longer, when one week has passed, perform the following:

- ▶ **Check the ink level.**
If "Ink Low" is displayed, replace the relevant ink cartridge.
- ▶ **Agitate the ink in the ink cartridge.**